



MACH VIET

Smart Motion - Smart Manufacturing

HỘP SỐ, BỘ TRUYỀN ĐỘNG

GIGA G+[®]

CÔNG TY CỔ PHẦN CÔNG NGHỆ MẠCH VIỆT CNC



Planetary Gearboxes/GPB Series



GPBR Series



Planetary Gearboxes/GPFR Series



Planetary Gearboxes/GPER Series



Planetary Gearboxes/GPF Series



Planetary Gearboxes/GPD Series



Planetary Gearboxes/GPVR Series



Planetary Gearboxes/GPLR Series



Planetary Gearboxes/GPE Series



Planetary Gearboxes/GPDR Series



Planetary Gearboxes/GPL Series



Planetary Gearboxes/GPV Series

HỘ SỐ TRỤC RỖNG

HỘ SỐ TRỤC RỖNG



GPW Steering Gear Series



Hollow Rotary Tables/GSB Series



Hollow Rotary Tables/GSR Series



GSR200



Hollow Rotary Tables/GSN Series



Hollow Rotary Tables/GSG Series



GSR150



GSR110



Worm Electric Rotary Table/GR Series



Hypoid Gear Rotary Table/GSH Series



GSR60



GSH60

HỘ SỐ TRỤC RỖNG

HỘ SỐ TRỤC RỖNG



GSH100



GSH150



GSN200



GSN280



GSB60



GSH200

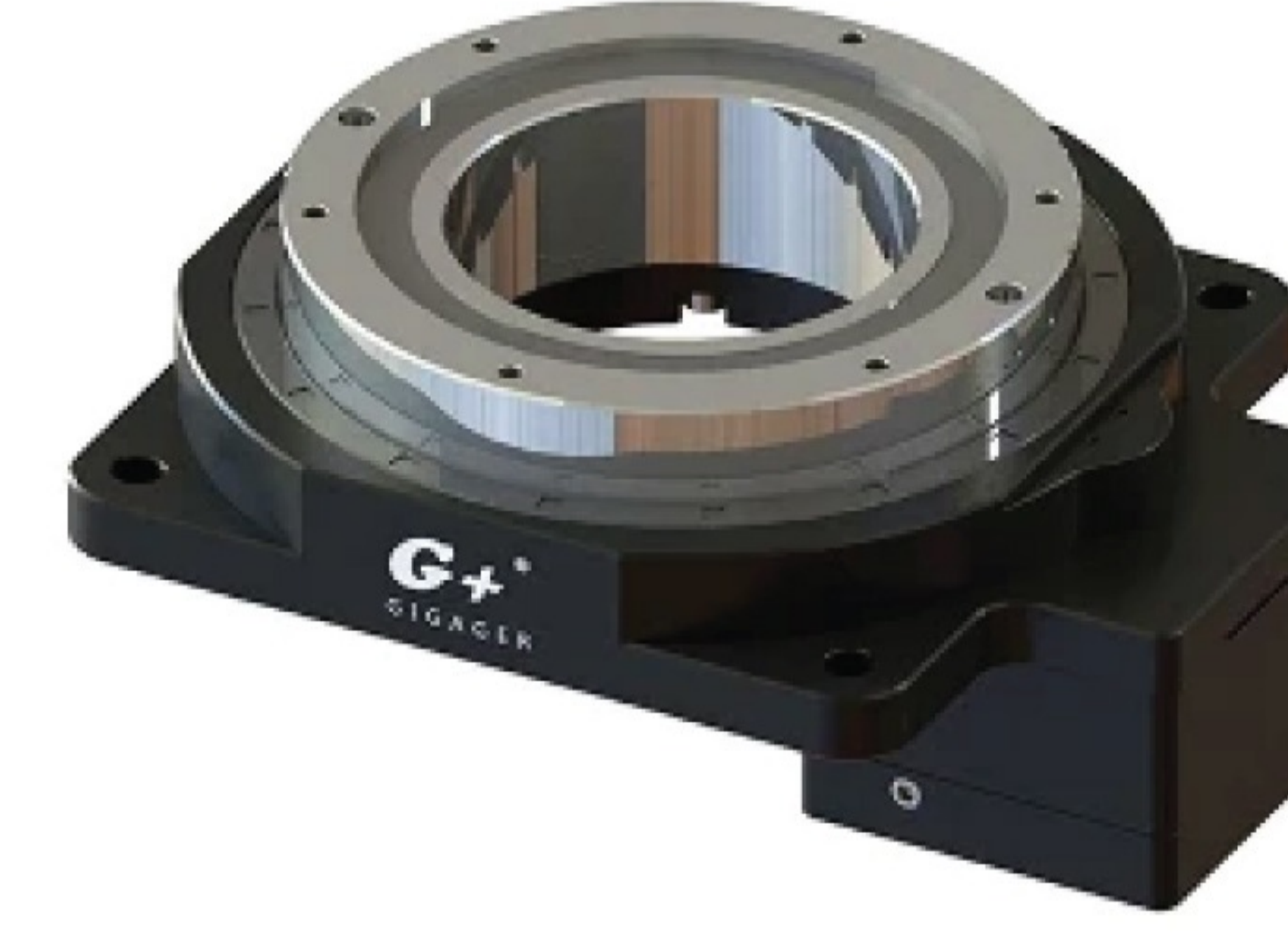

GSN450



GSN85-18K



GSN60



GSN130

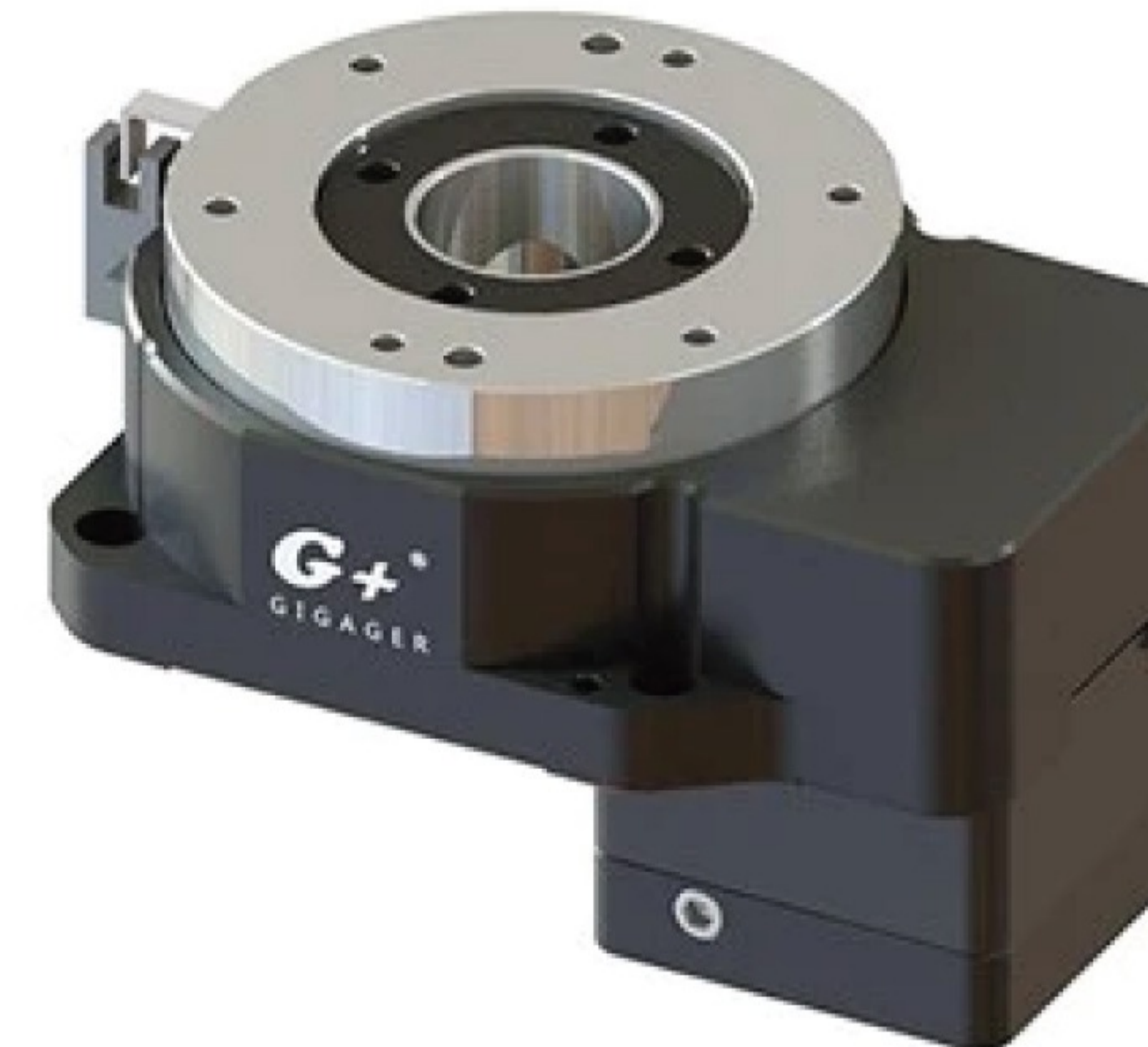

GSB100



GSB130

HỘ SỐ TRỤC RỖNG



GSB200

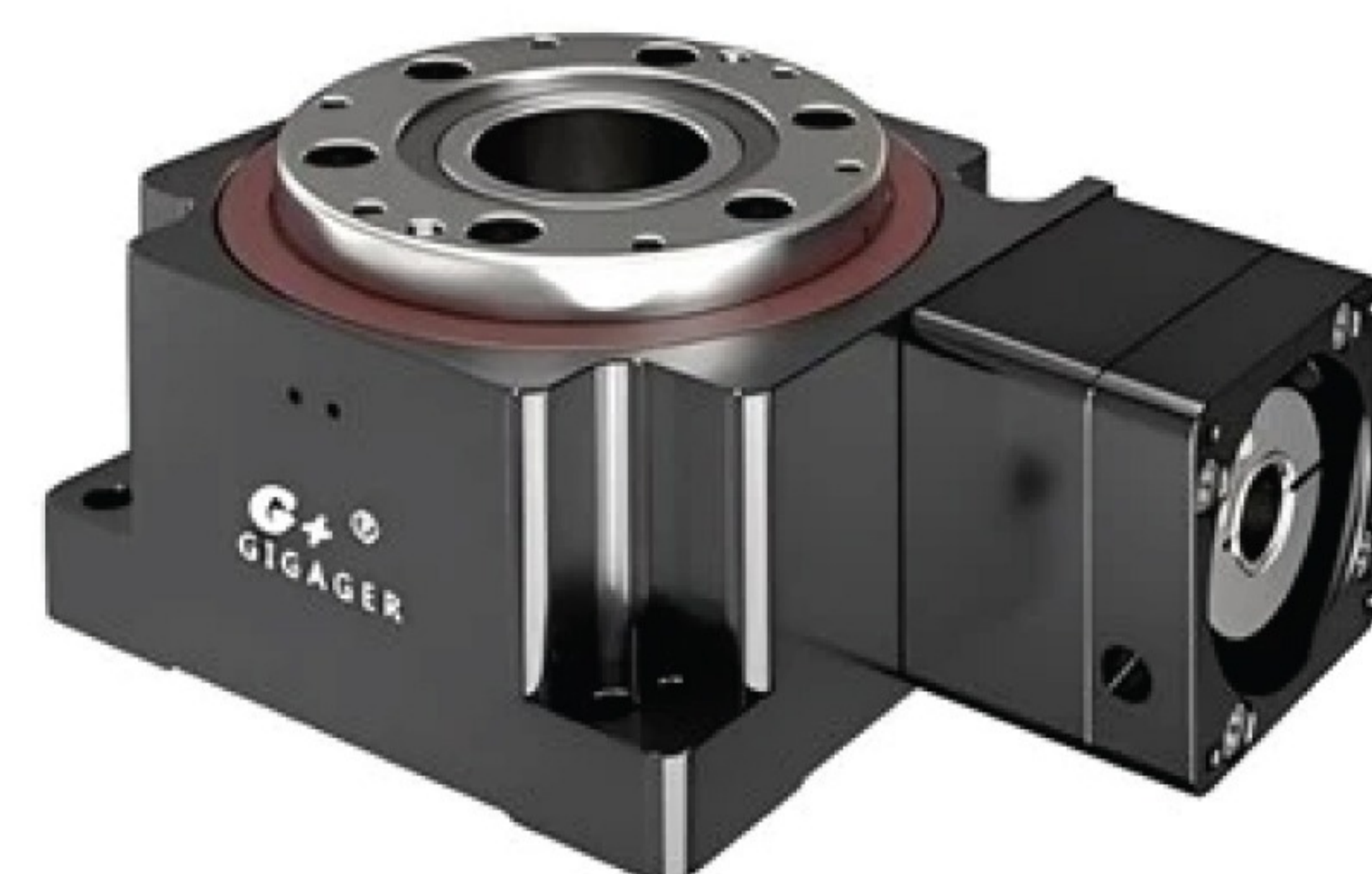

Hollow Rotary Tables /GSHR Series



Hollow Rotary Tables/GSA Series

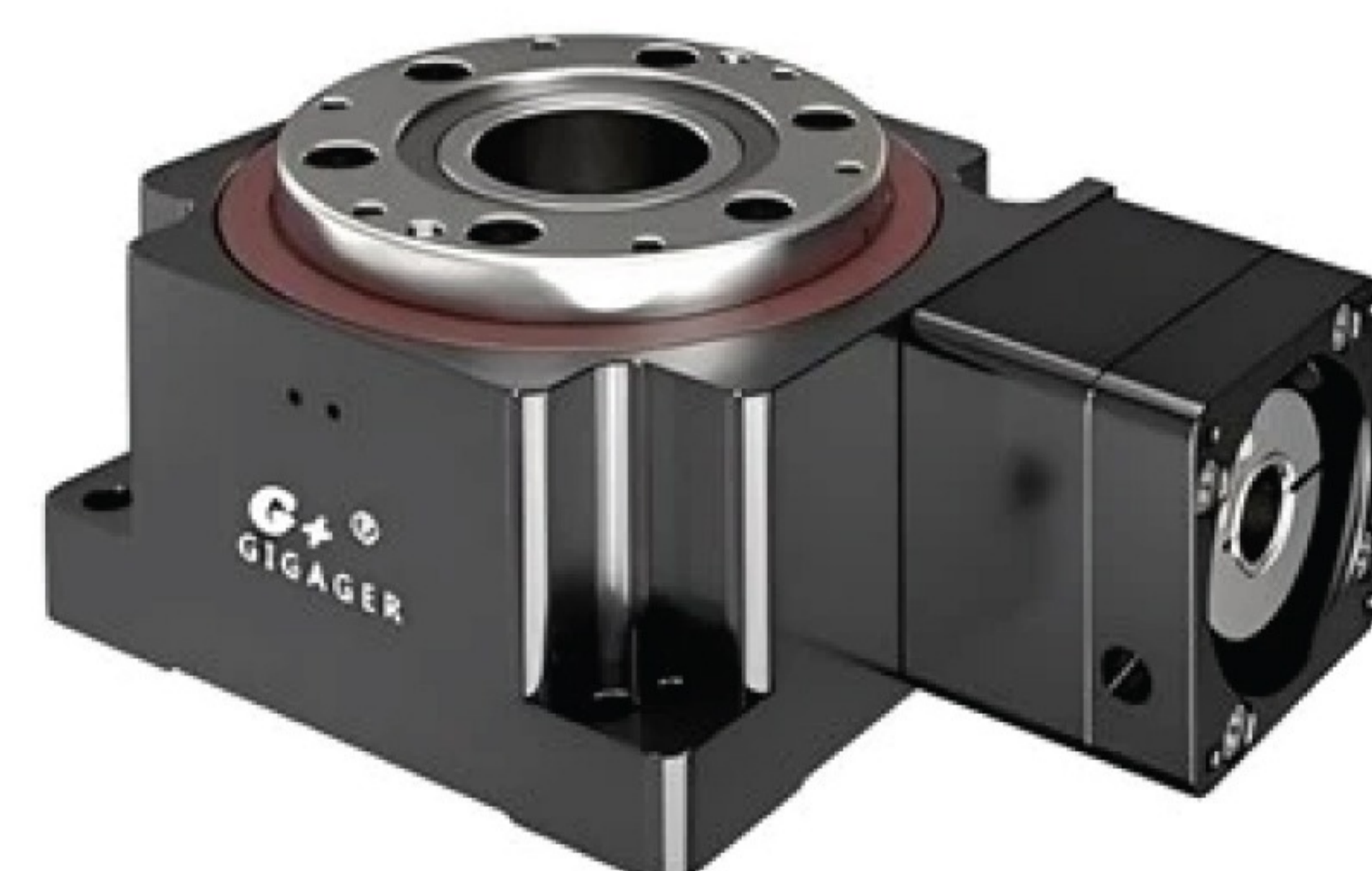

GSHR200



GSN85



GSG60

HỘ SỐ TRỤC RỖNG

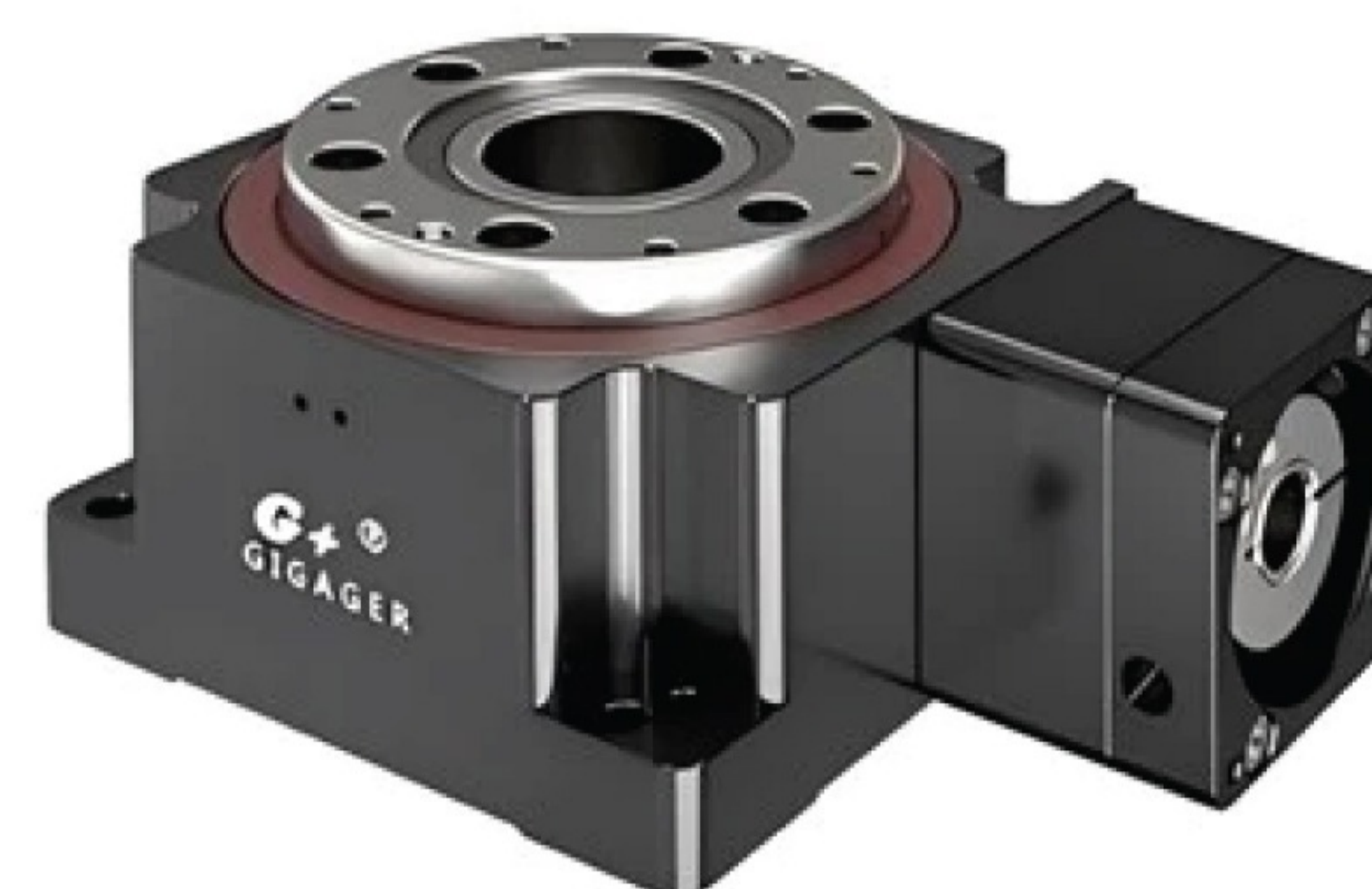

GSHR150



GSG85

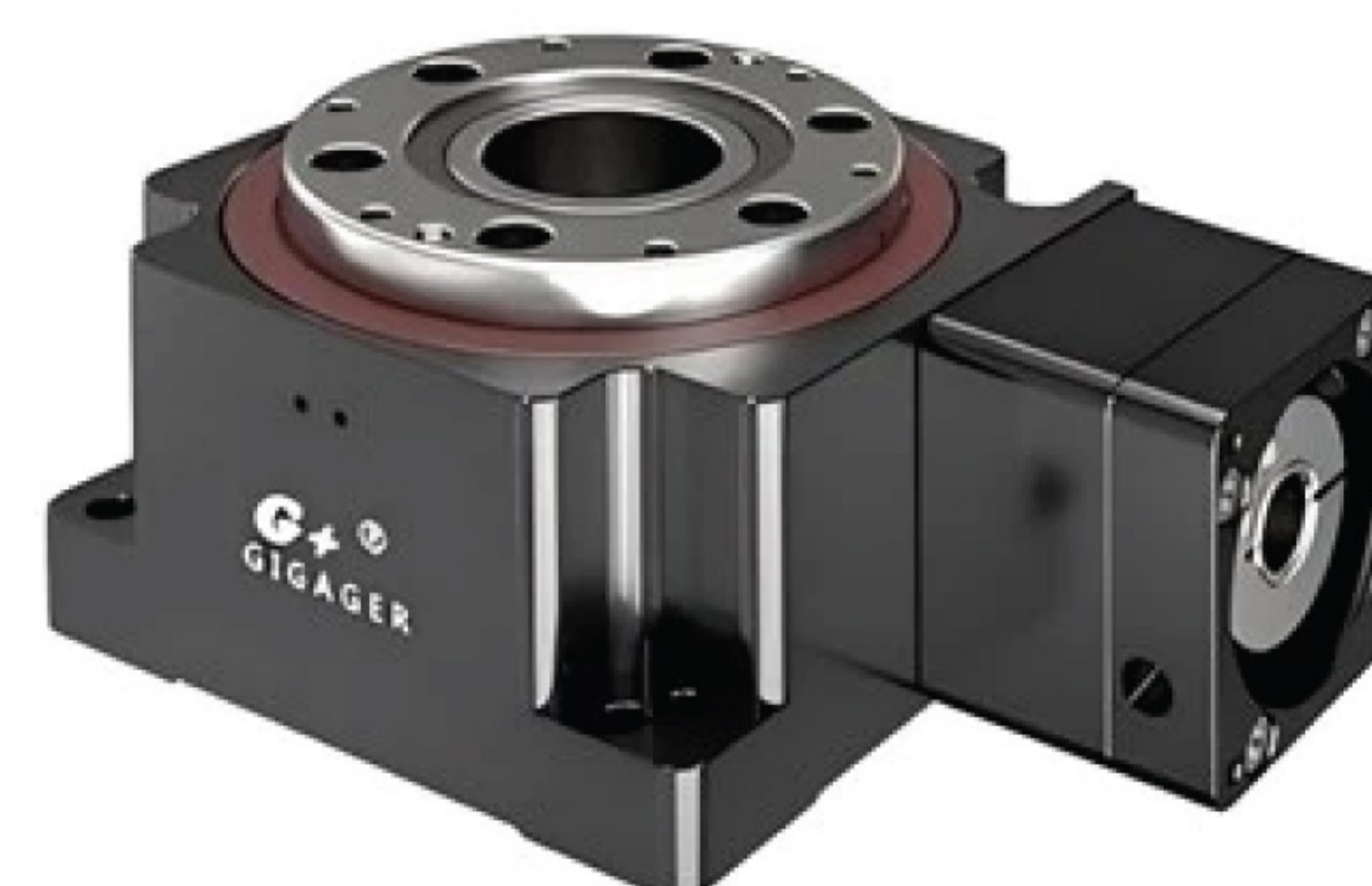

GSHR100



GSG130



GSG200



Right Angle Reducer



Right Angle Gearbox



90 Degree Speed Reducer



GMA85



GML60



Right Angle Gear Drives



GMR60

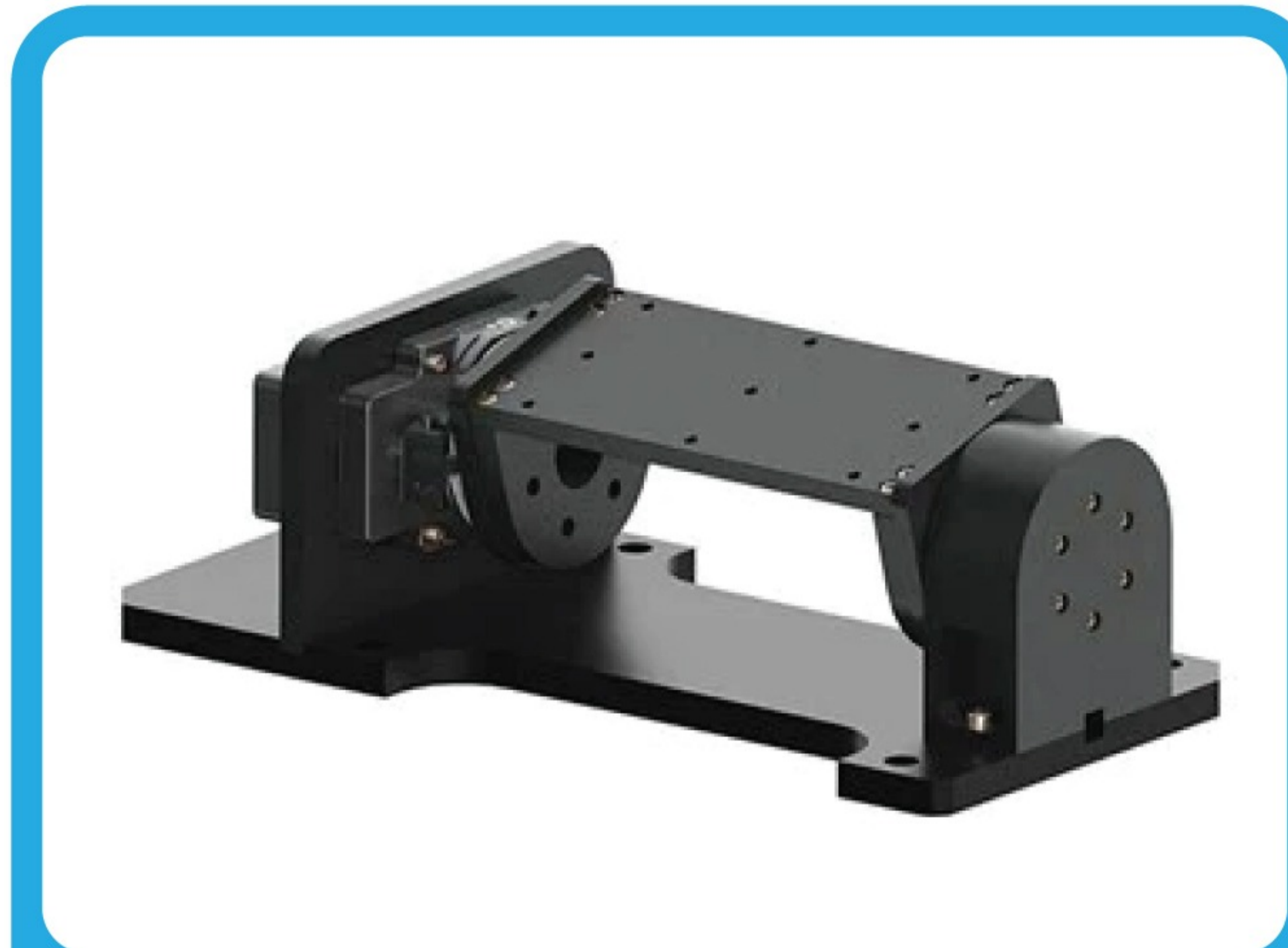

GML85



GHT Series/Short Cup

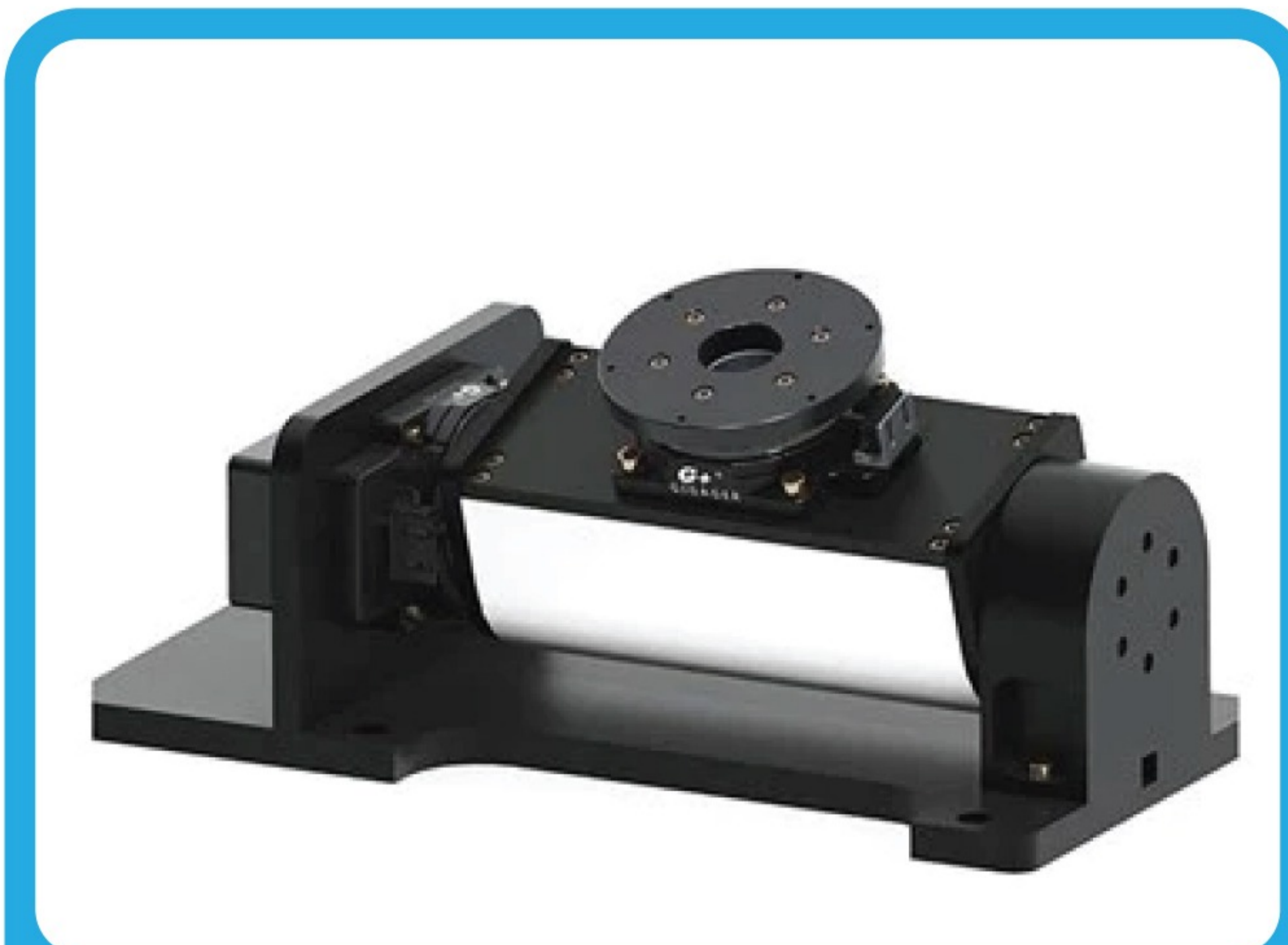

GMC60

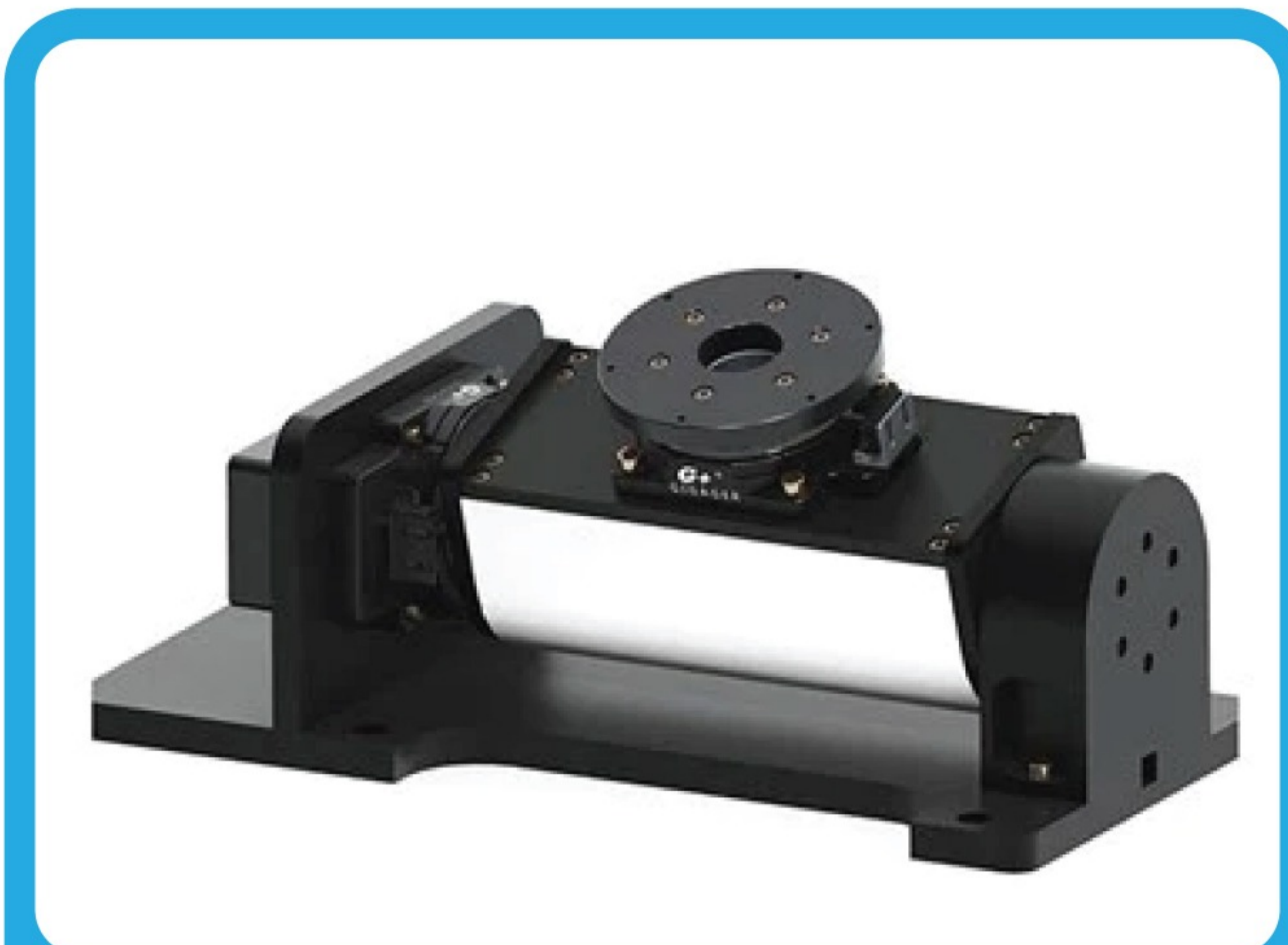

GMC85



GHD Series/Short Cup



GHC Series/Integrated

HARMONIC DRIVES

HARMONIC DRIVES/HOLLOW INDEXING TABLES



GHC Series/Self-aligning



GHS Series/Integrated



GHC Series/GHC-GA



**High Precision Rotary Stages
GSE Series**



GHS Series/Shaft Input



GHS Series/Self-aligning



High Torque Rotary Table/GBX Series



GYH315M



GHS Series/Hollow



GHC Series/GHC-GI



GYH215M



GYH115M

HOLLOW INDEXING TABLES



GYH82M



GYH68M



GYH48M



GYH90M



GYH Series



Ultra Thin Table Model DA Series

BỘ CHIA CAM



Table Model DT Series



Shaft Model DS Series



Flange Model DF Series



Hollow Flange Type DFH Series



Shaft Swaying Model DSU Series



Cam Indexing Drive

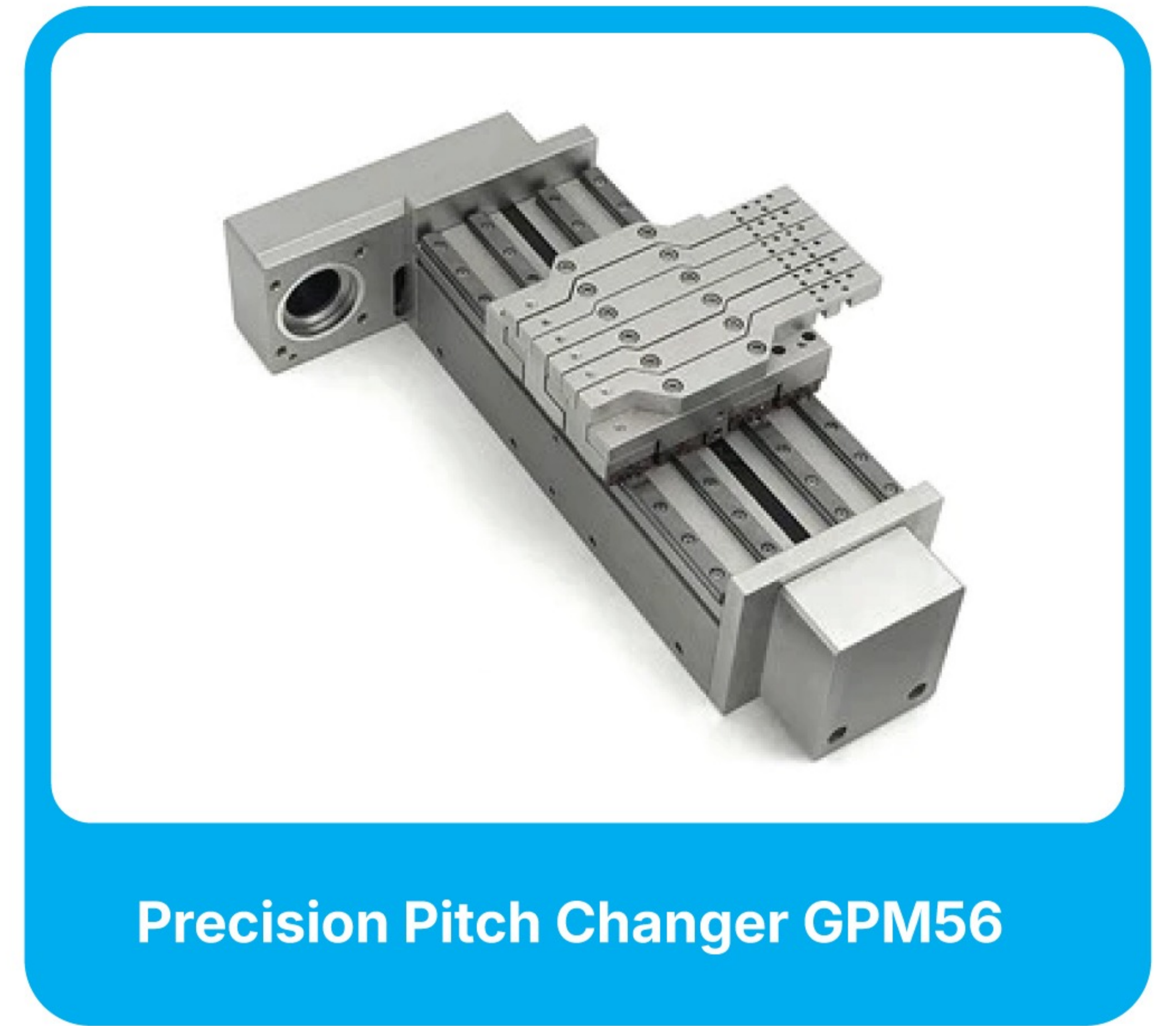
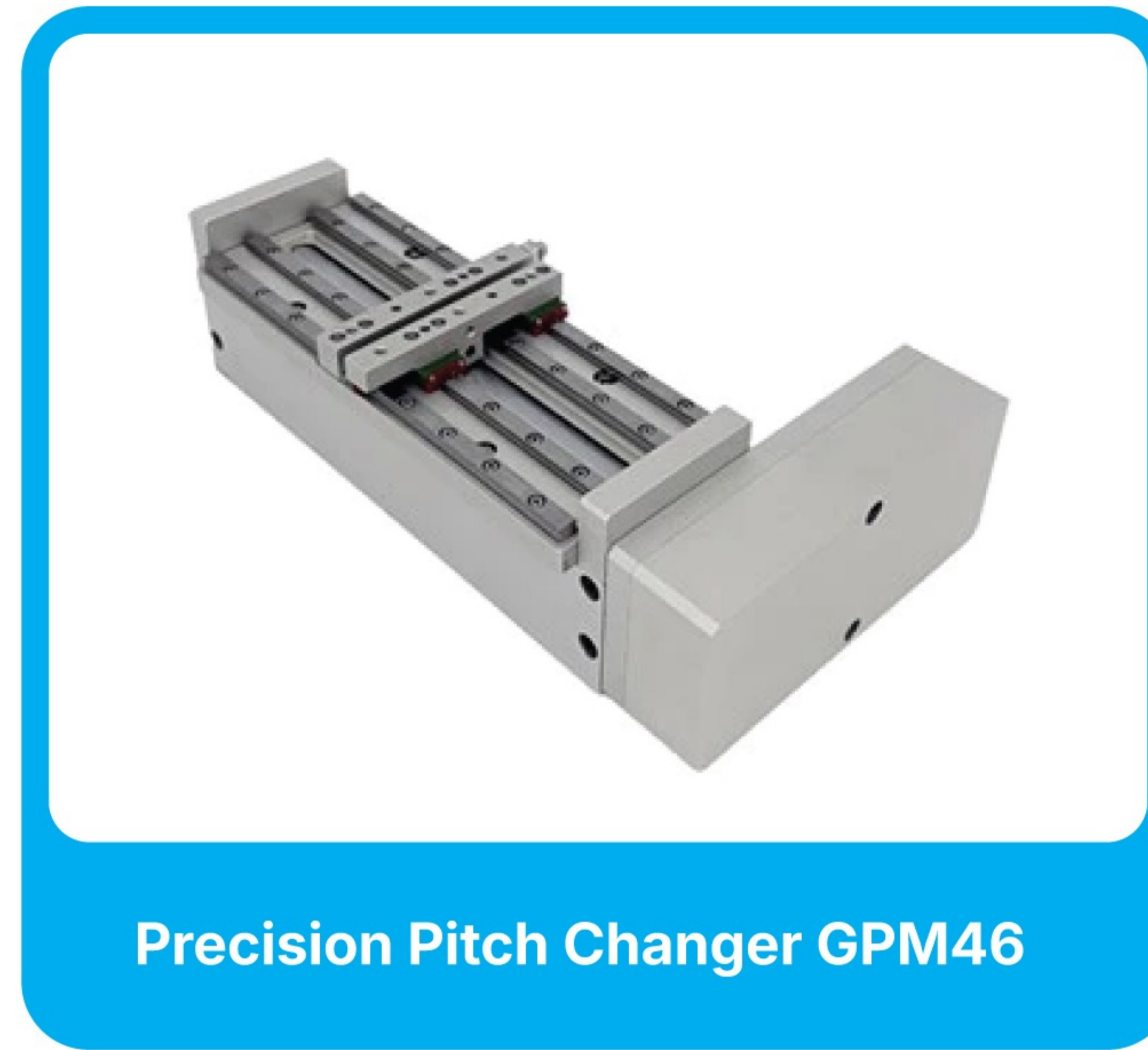
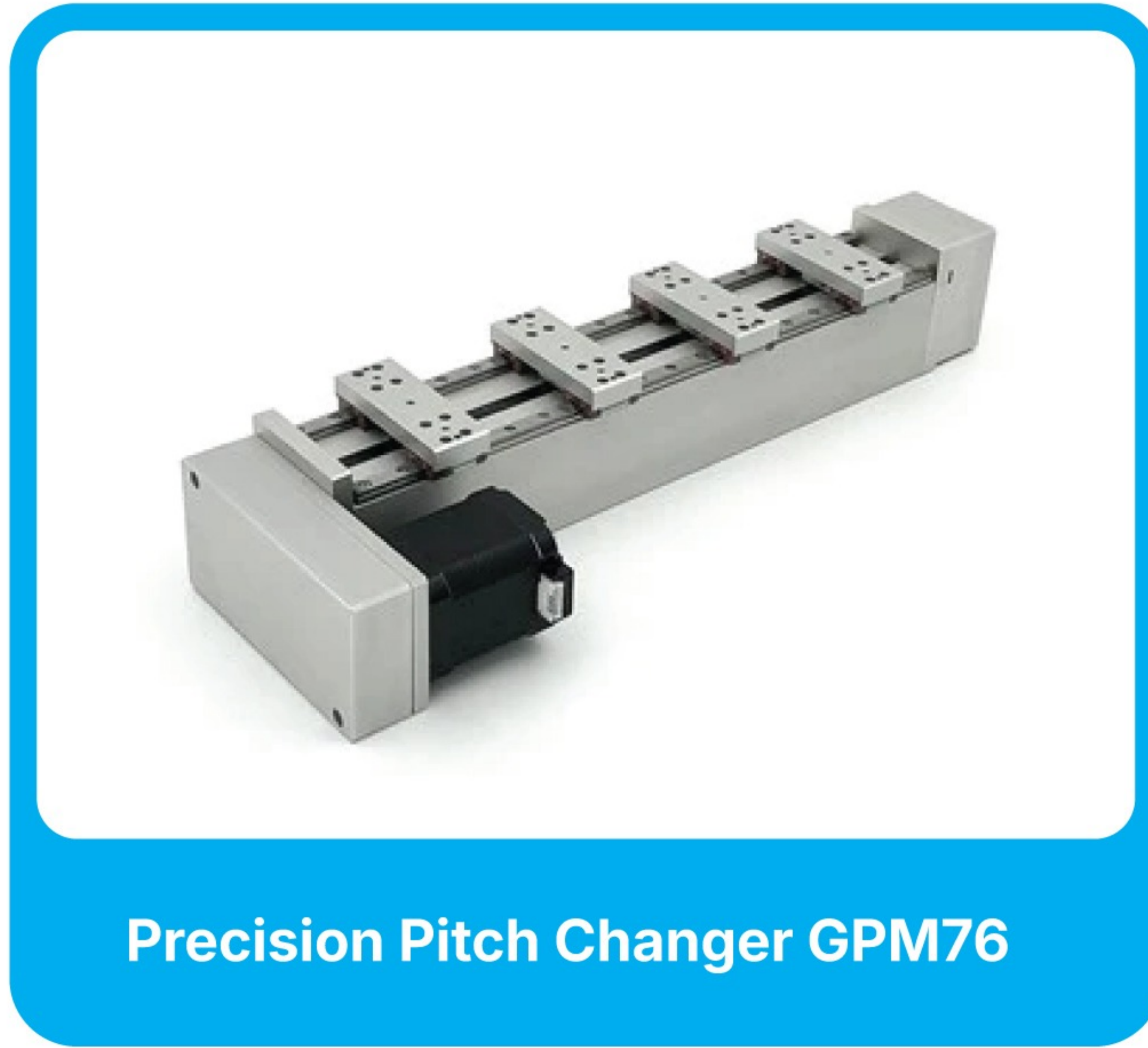
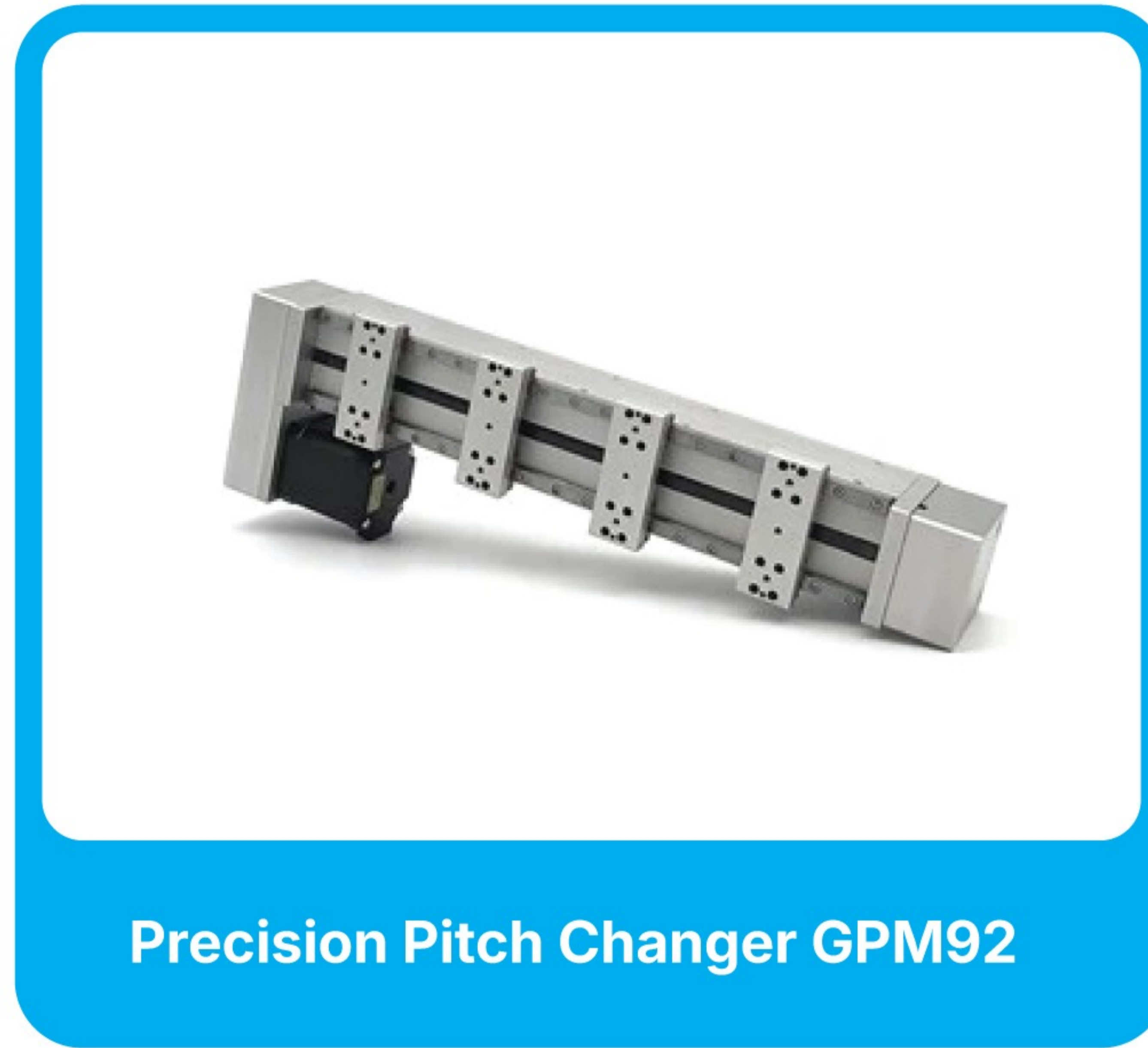

MACH VIET CNC TECHNOLOGY JSC.,



GIGAVIETNAM



Website

www.machviet.com

Email

machviet.hn@gmail.com

Địa chỉ kho

Số 95/68 Giáp Hải, Bát Tràng, Hà Nội